

sistemacciaio

nodi principali

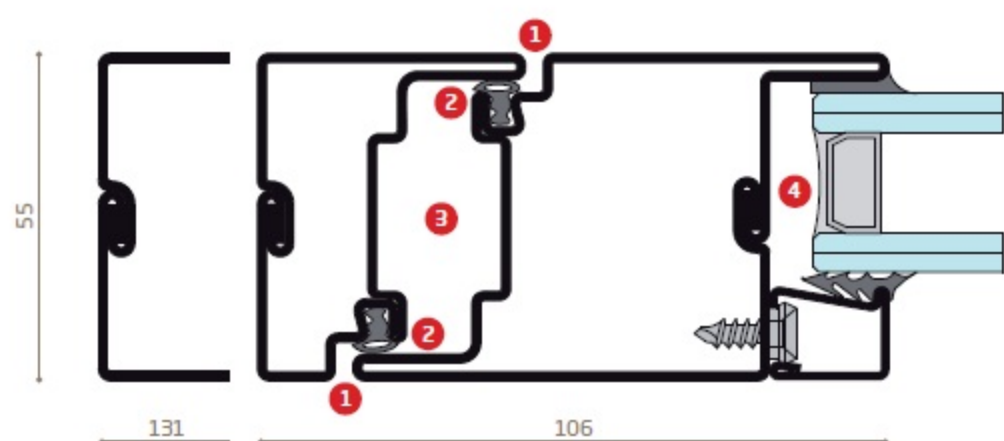

1. complanarità esterna ed interna
2. doppia guarnizione di battuta
3. camera europea 25 x 21 mm per ferramenta certificata
4. camera per alloggiamento vetri fino a 35 mm di spessore

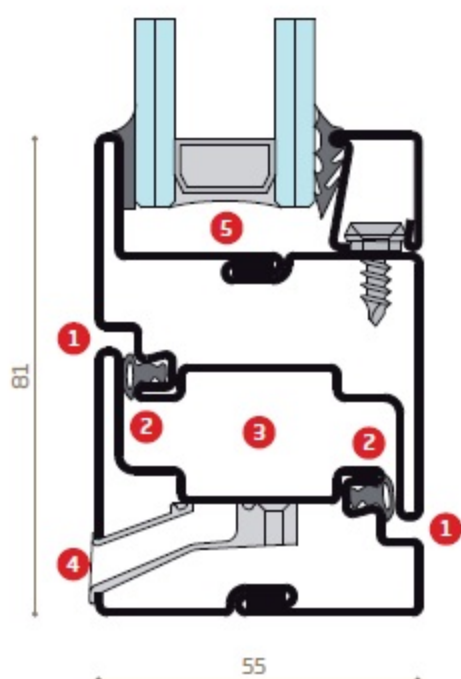

1. complanarità esterna ed interna
2. doppia guarnizione di battuta
3. camera europea 25 x 21 mm per ferramenta certificata
4. accessorio integrato per lo scarico dell'acqua
5. camera per alloggiamento vetri fino a 35 mm di spessore

profili

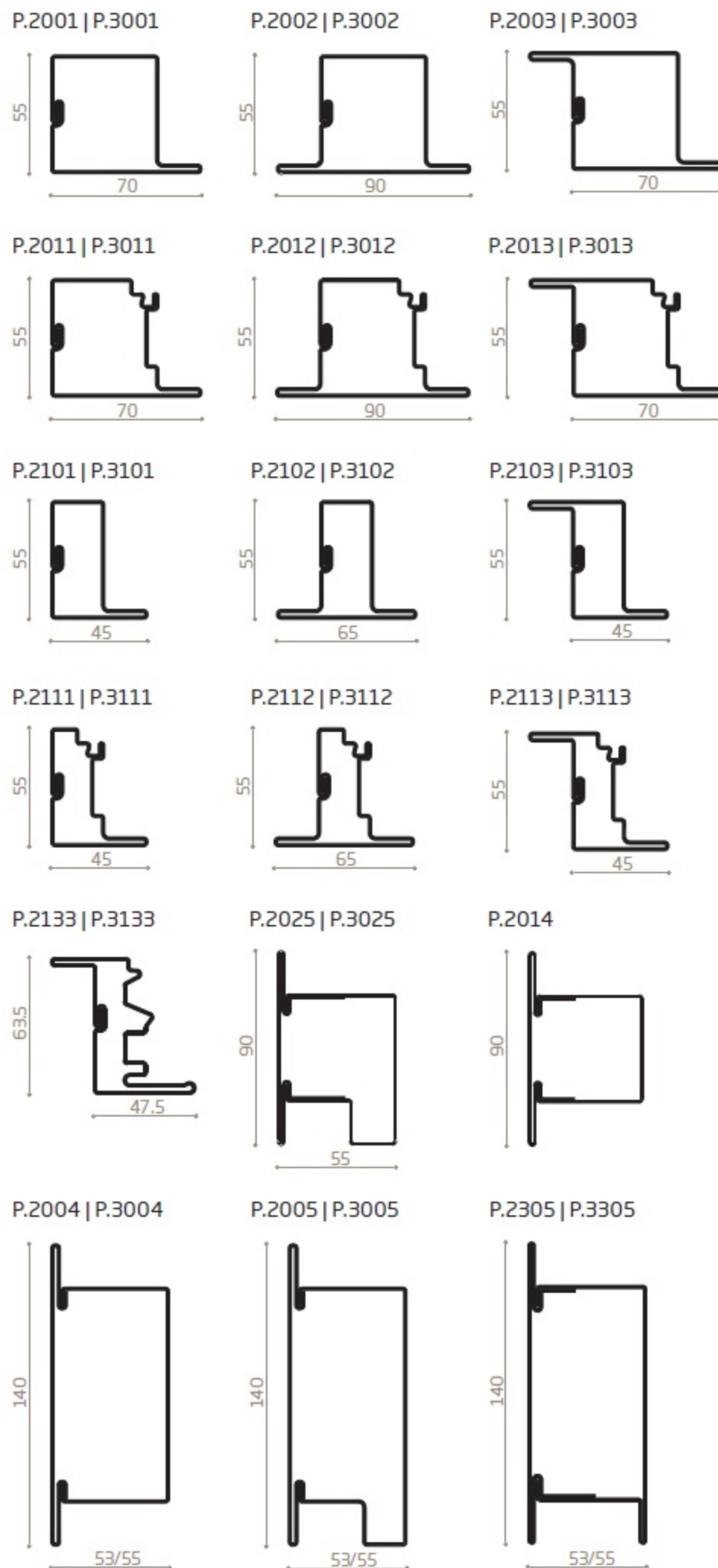

i profili sistemacciaio P.2--- sono forniti in acciaio inox e ottone con spessore 12/10
i profili sistemacciaio P.3--- sono forniti in acciaio zincato e acciaio corten con spessore 15/10

sezione verticale

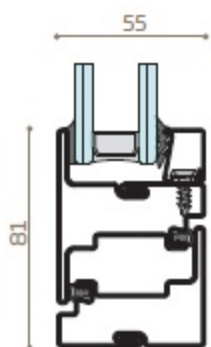
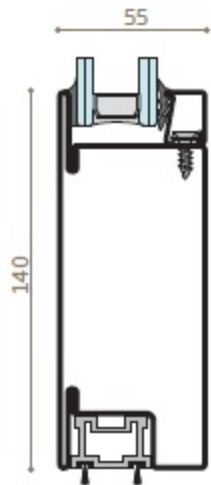
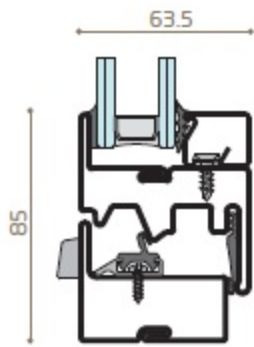
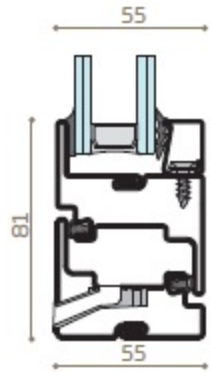

sezione orizzontale

